



# All Weather Siding Ceiling Installation Guide

v20220215US



**NewTechWood**

# **CONTENTS**

<a href="#">Important Note</a>	3 - 5
<a href="#">Ceiling Parts</a>	6 - 8
<a href="#">Expansion and Contraction Values Table</a>	9
<a href="#">Locking the Siding Board</a>	10 - 13
<b>Siding - Ceiling Installation</b>	
- <a href="#">Framing</a>	14
- <a href="#">Ceiling board installation</a>	14 - 18
- <a href="#">Trimming</a>	18 - 19

NOTE: Click on the heading to enter the section directly

### IMPORTANT Note:

## Read All Sections Before You Start

For the most up to date information, please visit our website @ [www.newtechwood.com](http://www.newtechwood.com)

Prior to installing any composite siding system, it is recommended that you check with local building codes for any special requirements or restrictions. The diagrams and instructions outlined in this guide are for illustration purposes only and are not meant or implied to replace a licensed professional. Any construction or use of NewTechWood must be in accordance with all local zoning and/or building codes. The consumer assumes all risks and liability associated with the construction and use of this product.

### Safety

When dealing with any type of construction project, it is necessary to wear appropriate safety equipment to avoid any risk of injuries. NewTechWood recommends, but is not limited to the following safety equipment, when handling, cutting, and installing NewTechWood: gloves, a respiratory protection, long sleeves, pants, and safety glasses.

### Tools

Standard woodworking tools may be used. It is recommended that all blades have a carbide tip. Standard stainless steel or acceptable coated deck screws and nails are recommended.

### Environment

A clean, smooth, flat, and strong surface is needed to install NewTechWood's products correctly. Please check with local building codes before ever installing any type of siding. If installation does not occur immediately, NewTechWood's products need to be put on a flat surface at all times. It should NEVER be put on a surface that is NOT flat.

### Planning

Plan a layout for your siding before starting it to ensure the best possible looking siding for your project. Building codes and zoning ordinances generally apply to permanent structures, meaning anything that is anchored to the ground or attached to the house. So nearly every kind of siding requires permits and inspections from a local building department. We recommend drawing out a site plan of your proposed project that you intend to do to minimize errors and make your perfect Siding.

**Pressure wash on a scrap piece of material before using a pressure washer on the deck to make sure that your settings will not damage the Ultrashield coating.**

### Construction

NewTechWood UltraShield is NOT intended for use as columns, support posts, beams, joist stringers, support against a force, or other primary load-bearing members. NewTechWood must be supported by a code-compliant substructure. While NewTechWood products are great for retrofits, NewTechWood's products CANNOT be installed on existing siding boards.

## Static

Static can also be more prevalent in areas that are of higher altitude because the humidity is lower. For these areas, be careful of using conductive objects such as metal railing and chairs as static shocks might occur more often. A potential way to lower the amount of static shocks occurring is to apply Staticide ([www.aclstaticide.com](http://www.aclstaticide.com)) on your deck or use anti-static mats before doorways.

## Ventilation

NewTechWood products CANNOT be directly installed onto a flat surface. It must be installed onto a substructure, so there is adequate and unobstructed air flow under the cladding to prevent excessive water absorption. A minimum of 1" (25mm) of continuous net free area under the siding surface is required for adequate ventilation on all siding, so air can circulate between adjacent members to promote drainage and drying.

## Heat and Fire

Excessive heat on the surface of NewTechWood products from external sources such as but not limited to fire or reflection of focussing sunlight from some optical objects can potentially harm NewTechWood products. This extreme elevation of surface temperatures, which exceeds that of normal exposure, can possibly cause NewTechWood products to melt, sag, warp, discolor, increase expansion/contraction, and accelerate weathering.

## Fasteners

When fastening NewTechWood's products all screws that are face fastened should always be driven in at a 90 degree angle to the siding surface. Toe nailing/screwing should never be done to the products. An extra joist should be added if a 90 degree angle cannot be driven into the board. All fasteners should be on their own independent joists, when two boards ends meet each other there must be a sister joist. The end of each board must sit on its own joist.

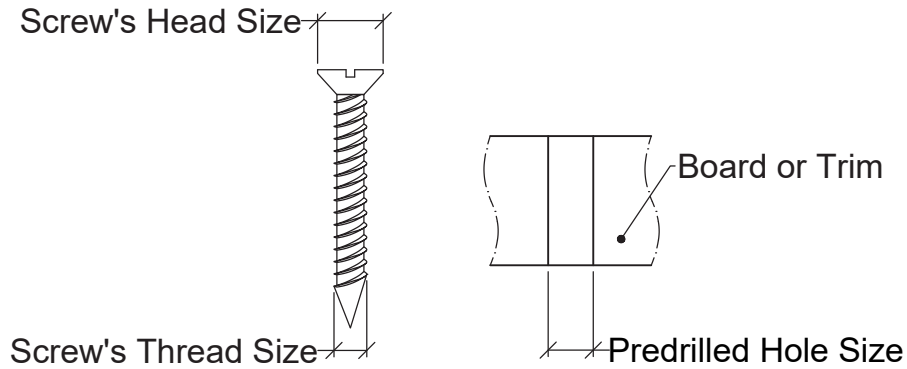
Use white chalk, straight boards, or string lines as templates for straight lines. NEVER USE COLORED CHALK. Colored chalk will permanently stain NewTechWood's products and are highly not recommended.

All nails/screws that are face fixed should always be stainless steel. Depending on the screws that you use when face fixing, there could be potential bulging or mushrooming. It is recommended to take care of these mushrooms/bulges by taking a rubber mallet and patting them down to give your siding a better look.

When choosing which screws/nails to use always check first with your local home centers and hardware stores to see if they have screws that are engineered specifically for composite wood. These screws/nails will always work and give NewTechWood's products the best looking outcome, using other screws/nails that are not recommended for composite could potentially damage/harm the cladding. If you are unsure which screw/nail to use, contact your manufacturer for more information.

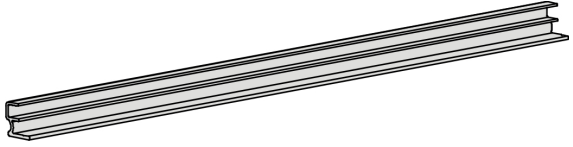


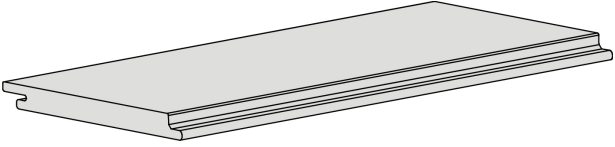
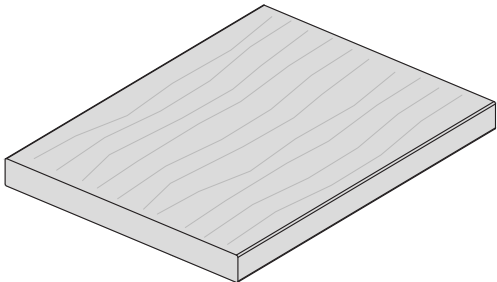
## Predrill

It is recommended to use the #8 screw for face fixing the boards and the trims onto the joist. When face fixing, it is recommended to predrill a slightly bigger hole on the board and the trim to allow for expansion and contraction, as shown in the below diagram,



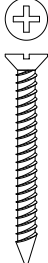
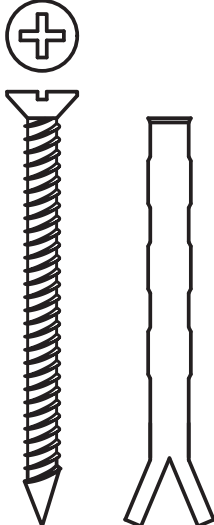
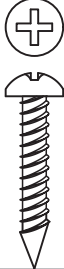

The predrilled hole size should be larger than the screw's thread size, from 1/16" (1.5 mm) to 5/64" (2 mm). Moreover, the predrilled hole size should also be smaller than the screw's head size, at least 5/64" (2 mm). A washer can be applied if the screw's head size is larger than the predrilled hole size, if it's below 5/64" (2 mm).

## Ceiling Parts

Product	Purpose	Part
<b>AW-02</b>	Used for the installation of the first board	
<b>AW-08</b>	Used at every joist to fix each board to the joist	
<b>T-7</b>	Used on the last Siding board	
<b>US09</b>	Siding Board	
<b>US05</b>	Used for the trimming	

# Ceiling Screws (For Wood Joist)


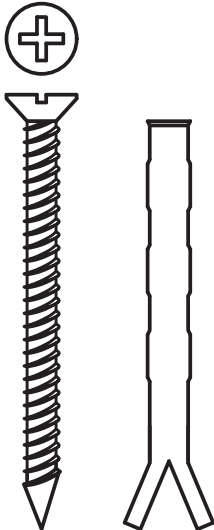


The table below shows the screws recommended to use for the installation, but not included.

Product	Purpose	Part
<p><b>#5 x 1 1/4"</b> <b>Stainless Steel</b> <b>SS304</b></p>	<p>Used when locking the board into the Clip (AW08)</p>	
<p><b>#8 x 3"</b> <b>Stainless Steel</b> <b>SS304</b> <b>**depends on the thickness of your joists</b></p>	<p>Used when installing the joist onto the wall</p>	
<p><b>#8 x 1"</b> <b>Stainless Steel</b> <b>SS304</b> <b>(Pan Head)</b></p>	<p>Used when installing the Clip (AW08) and the Rubber Stopper (T-7) onto the wood joists</p>	
<p><b>#8 x 1 1/4"</b> <b>Stainless Steel</b> <b>SS304</b> <b>(Flat Head)</b></p>	<p>Used when installing the boards and the trims onto the wood joists</p>	



# Ceiling Screws (For Aluminum Joist)

The table below shows the screws recommended to use for the installation, but not included.

Product	Purpose	Part
<b>#5 x 1 1/4"</b> <b>Stainless Steel</b> <b>SS304</b>	Used when locking the board into the Clip (AW08)	
<b>#8 x 3"</b> <b>Stainless Steel</b> <b>SS304</b> <b>**depends on the thickness of your joists</b>	Used when installing the joist onto the wall	
<b>#8 x 1"</b> <b>Stainless Steel</b> <b>SS410</b> <b>(Pan Head)</b>	Used when installing the Clip (AW08) and the Rubber Stopper (T-7) onto the aluminum joists	
<b>#8 x 1 1/4"</b> <b>Stainless Steel</b> <b>SS410</b> <b>(Flat Head)</b>	Use when installing the boards and the trims onto the aluminum joists	

\*Note: All screws are based on our recommendation and if the installation requires something different than what is shown, a professional should be consulted before installing.

The following installation guide will use the above screw sizes.



# Expansion and Contraction Values

NewTechWood siding boards will experience expansion and contraction with changes in temperature. Expansion and contraction are most significant where extreme temperature changes occur. Fastening the deck planks according to the gapping requirements noted in the following table accommodates for this movement.

## Expansion and Contraction table of values for North America, Canada, Australia and Asia

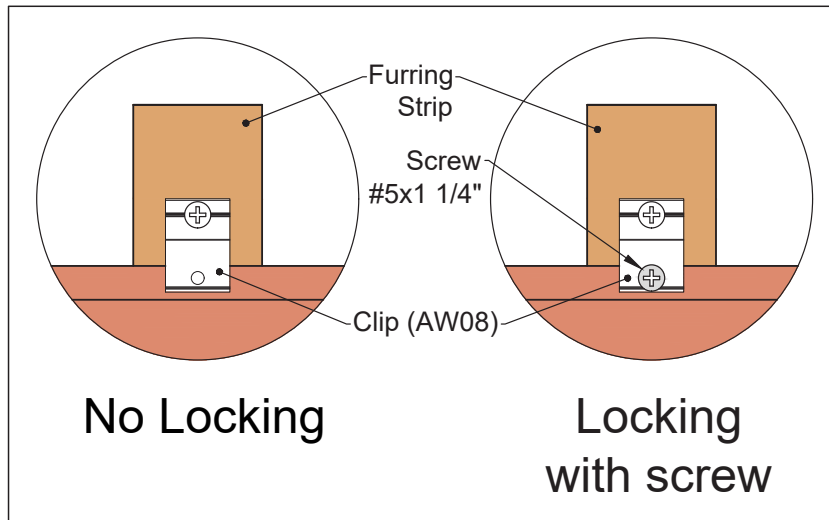
		Length (Feet)								
		3	8	9	10	12	13	16	18	
Installation Temperature (Farhenheit)	<b>32</b>	1/16	2/16	2/16	3/16	3/16	4/16	4/16	5/16	Gap (in)
	<b>41</b>	1/16	2/16	2/16	2/16	3/16	3/16	4/16	4/16	
	<b>50</b>	1/16	2/16	2/16	2/16	2/16	3/16	3/16	3/16	
	<b>59</b>	1/16	1/16	1/16	2/16	2/16	2/16	2/16	3/16	
	<b>68</b>	3/64	1/16	1/16	1/16	1/16	2/16	2/16	2/16	
	<b>77</b>	3/64	1/16	1/16	1/16	1/16	1/16	1/16	1/16	
	<b>86</b>	3/64	3/64	3/64	3/64	3/64	1/16	1/16	1/16	

Note: If you are still unsure of what gapping to use, contact the manufacturer and they will give you the correct gapping requirements based on your environment and area.

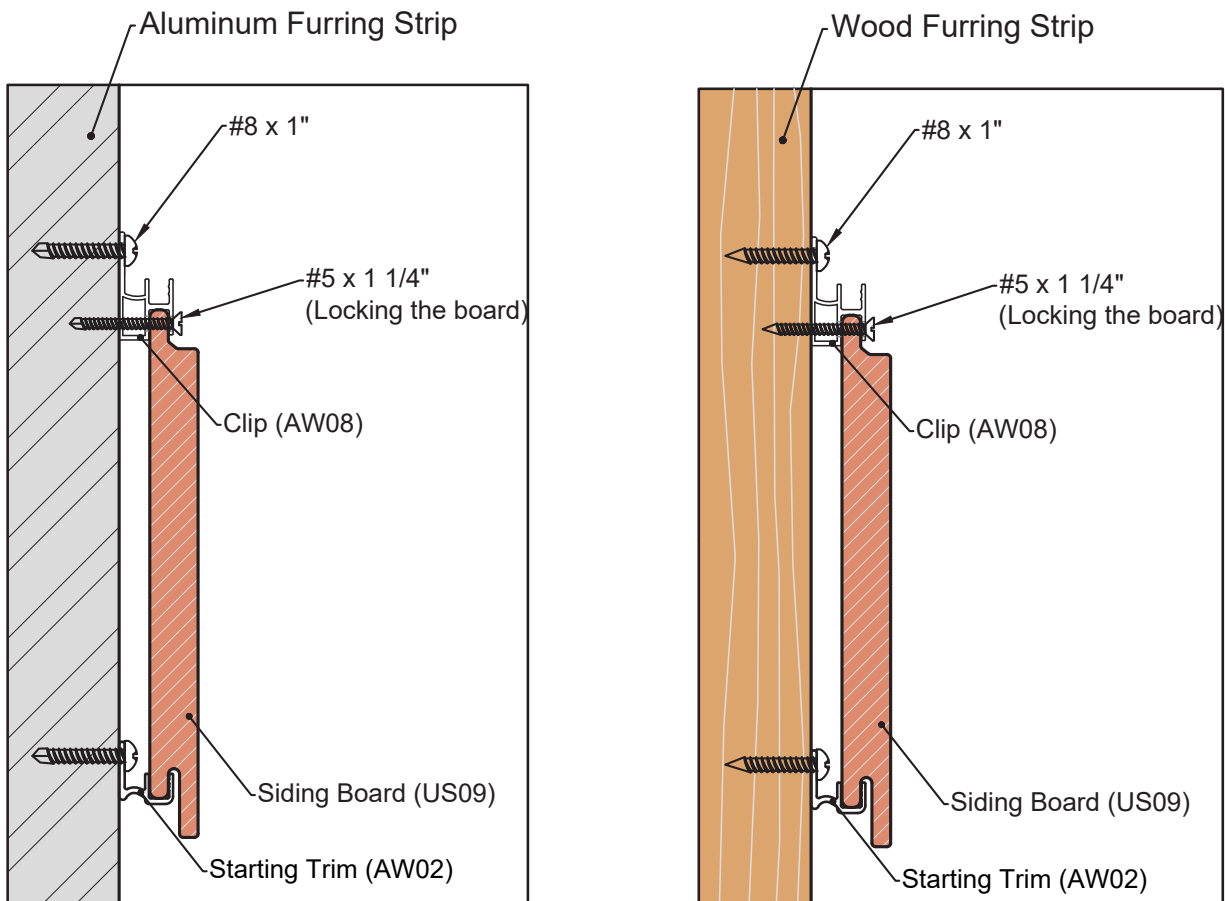
# Locking the Siding Board

Since the composite wood must allow for expansion and contraction due to temperature change, the board must be locked at one fixed point but only one point to allow the remaining board to expand and contract freely. In the case there is a need to lock the board, Clip (AW08) comes with a separate hole.

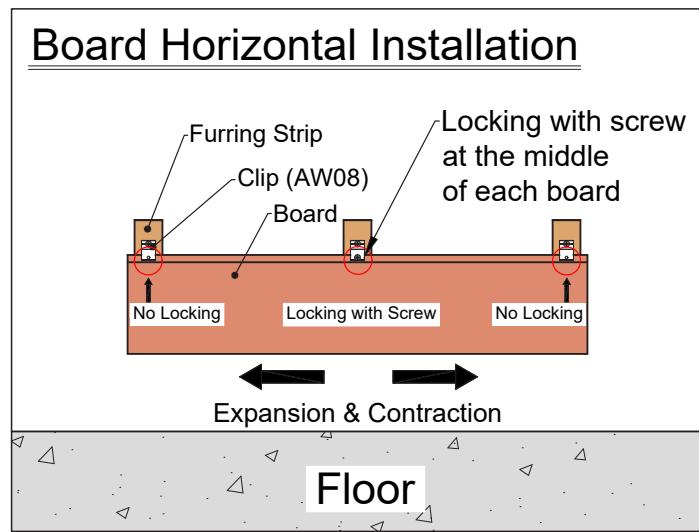
It is important that **DO NOT LOCK** any other clips for the same board.



## - Horizontal Installation -

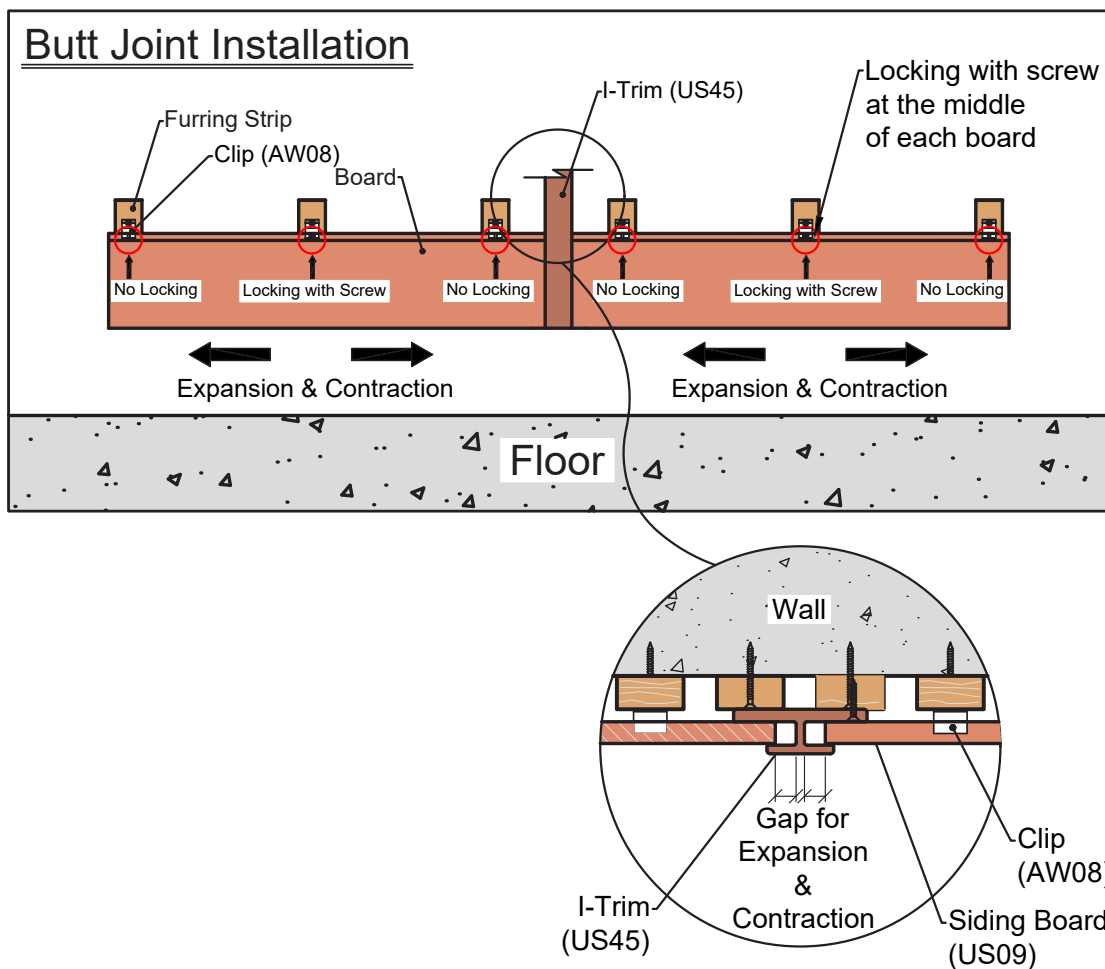


When installing horizontally, it is required to lock the Clip (AW08) at the middle of the board, as shown in **Diagram 1**.



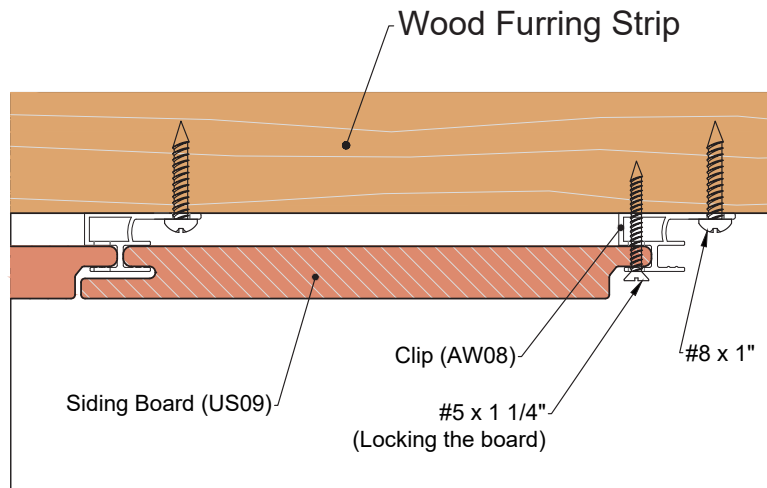
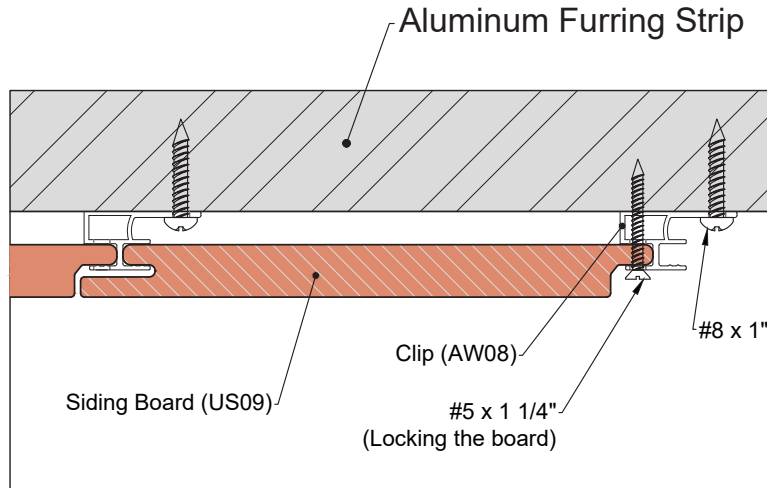
**Diagram 1**

When installing more than one board horizontally, it is recommended to utilize the I-Trim (US45) at each butt joint. It is also required to lock the Clip (AW08) at the middle of each board, as shown in **Diagram 2**.

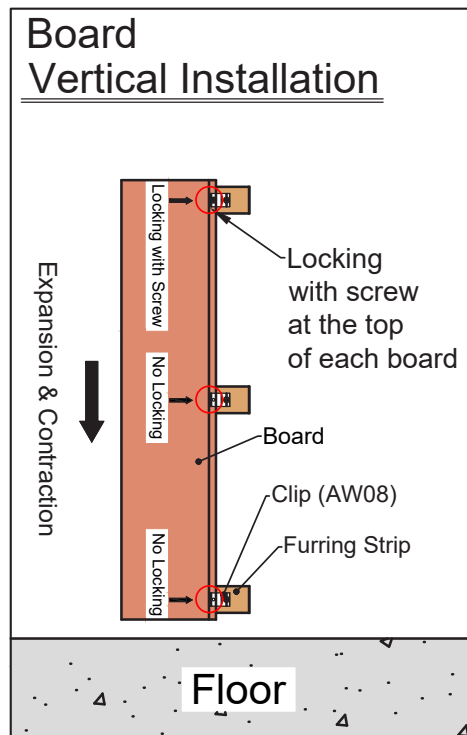


**Diagram 2**

- Vertical Installation -

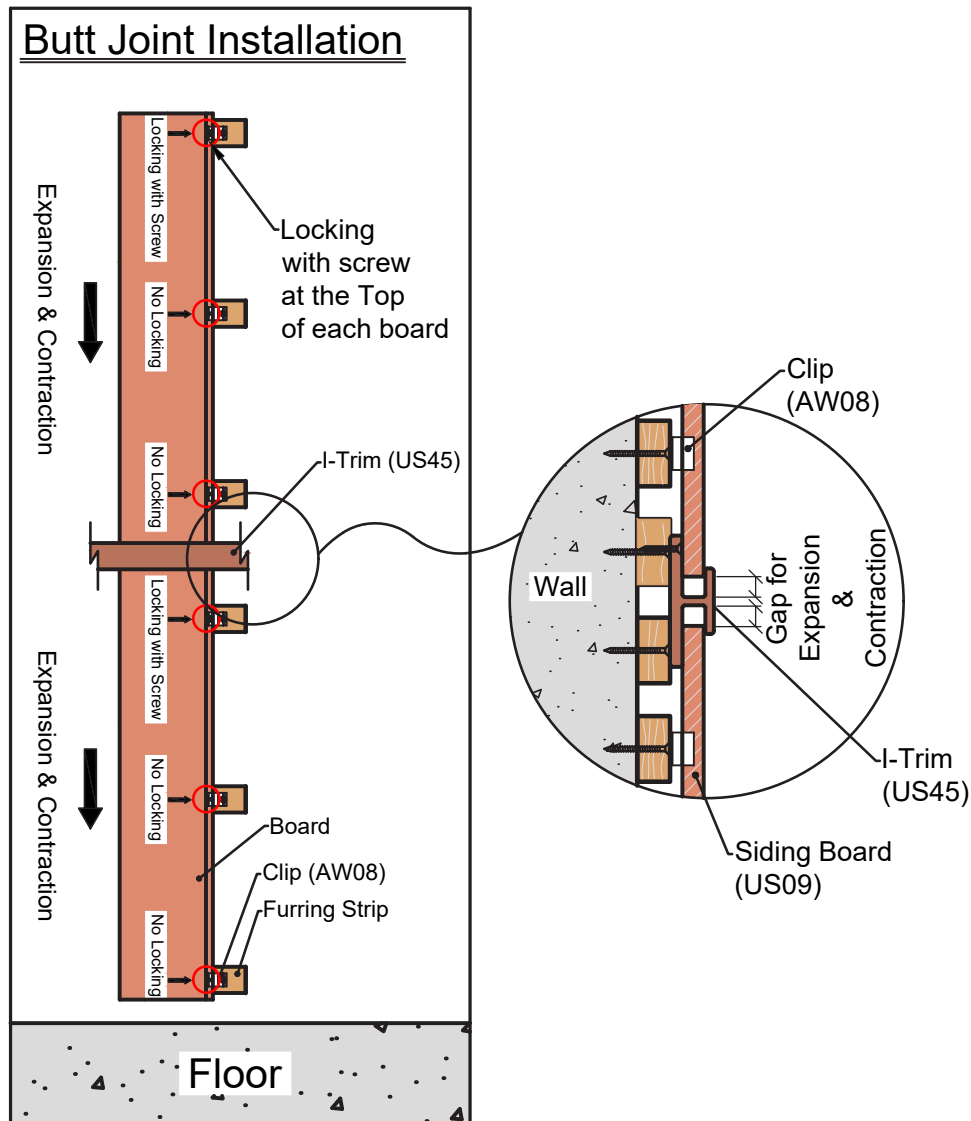


When installing vertically, it is required to lock the Clip (AW08) at the top of the board, as shown in **Diagram 3**.



**Diagram 3**

When installing more than one board vertically, it is recommended to utilize the I-Trim (US45) at each butt joint. It is also required to lock the Clip (AW08) at the top of each board, as shown in **Diagram 4**.

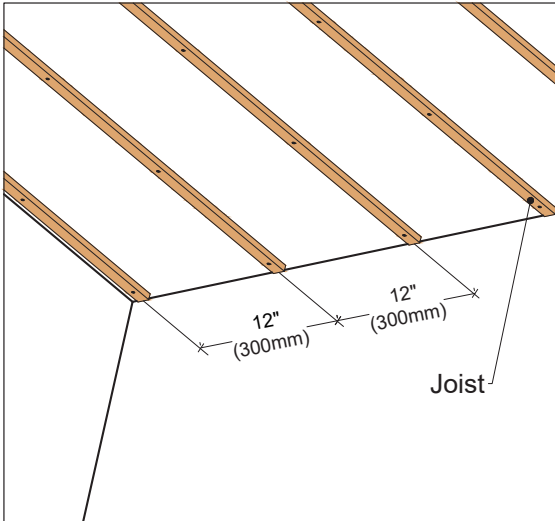


**Diagram 4**

# Ceiling Installation

## 1 Framing

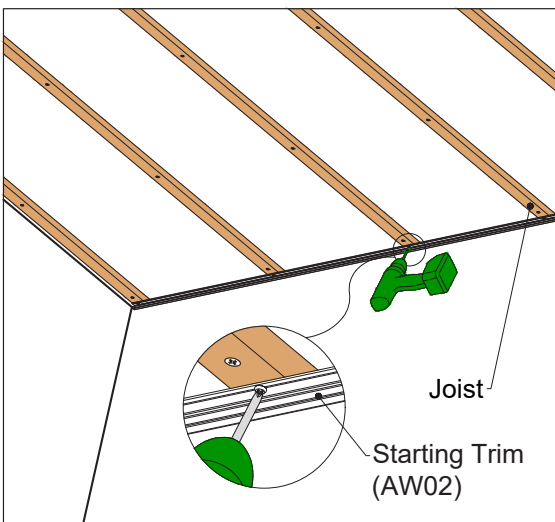
Fix the joists onto the ceiling where you intend to install the board. It is recommended to apply the joist span of not more than 12" (300mm), as shown in [Diagram 92](#).



**Diagram 92**

2 Fasten the Starting Trim (AW02) onto the end of the joist with screws, as shown in [Diagram 93](#).

**Note:**  
1. Pre-drill the screw holes for the Starting Trim (AW02) before installation.



**Diagram 93**

## 3 Ceiling board installation

Put the Siding Board (US09) over the Starting Trim (AW02) and fasten it to the joist with Clip (AW08), as shown in [Diagram 94](#) and [Diagram 95](#).

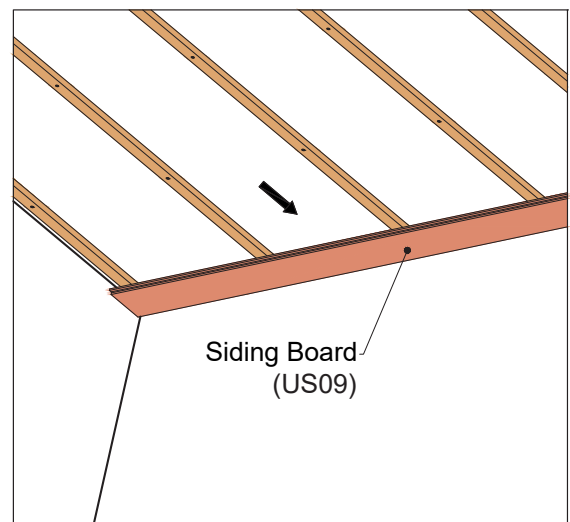
**Note:**

1. Since the composite wood must allow for expansion and contraction due to temperature change, the board must be **locked at one fixed point but only one point** to allow the remaining board to move freely. When installing horizontally, it is required to **lock the Clip (AW08) at the middle of each board**, as shown in [Detail 95-1](#).

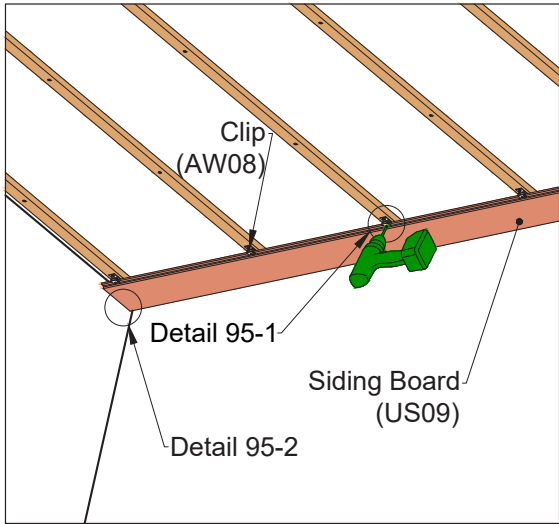
**DO NOT LOCK** any other Clip (AW08) for the same board.

Please review [page 10](#), "[Locking the Siding Board](#)" of this installation guide for further information.

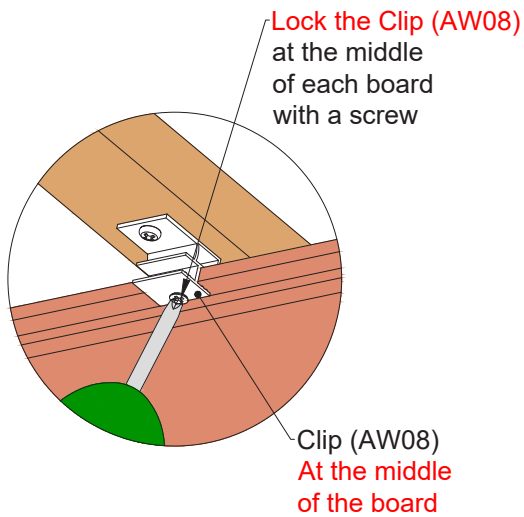
2. The gap between the Siding Board (US09) and the adjacent walls is vital to avoid warping or buckling, as shown in [Detail 95-2](#). Please select the appropriate gap value according to the [Expansion and Contraction Values Table](#) on [page 9](#) of this installation guide.



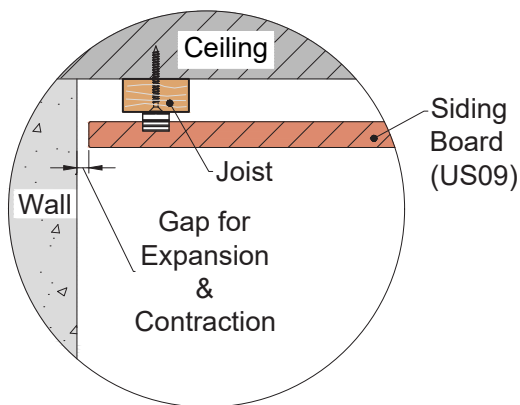
**Diagram 94**



**Diagram 95**

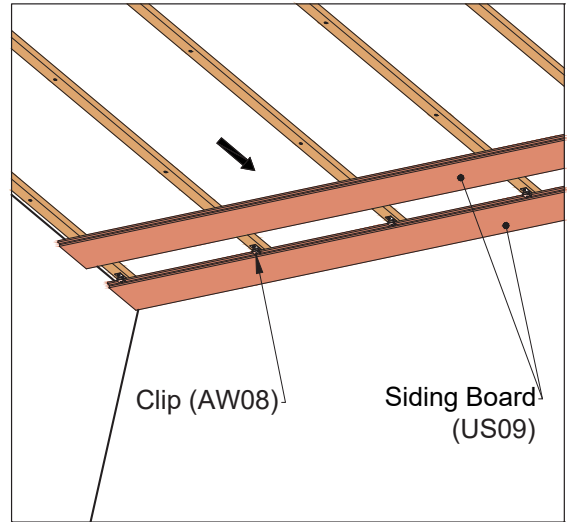


**Detail 95-1**



**Detail 95-2**

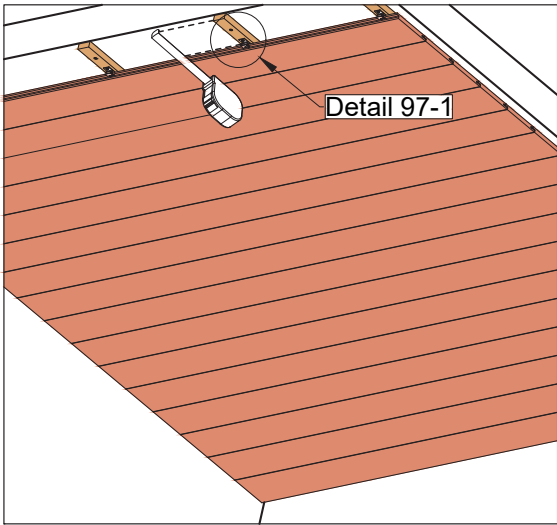
- 4 Put the next Siding Board (US09) in place and slide it inside the Clip (AW08), as shown in **Diagram 96**. Then fasten it to the joist with Clip (AW08), repeat the same procedure as installation Step 3.



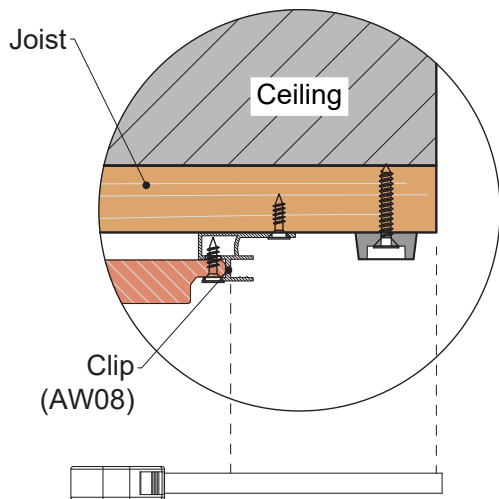
**Diagram 96**



- 5 When you are at the Siding's last board, measure the distance between the end of the joist and the Clip (AW08), as shown in **Diagram 97** and **Detail 97-1**.

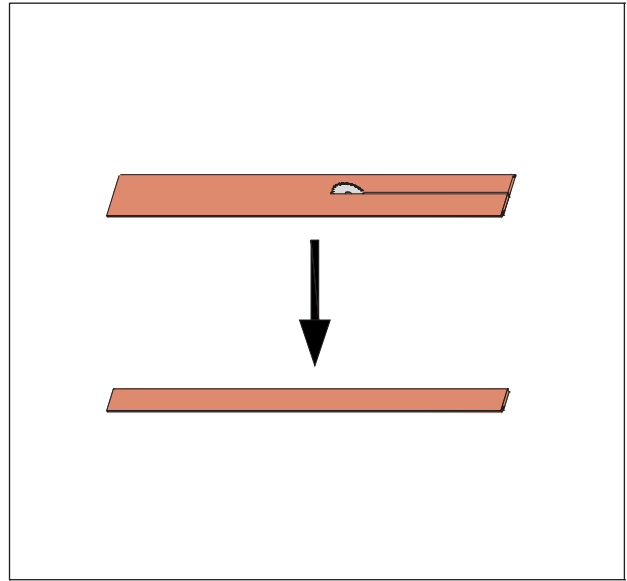


**Diagram 97**

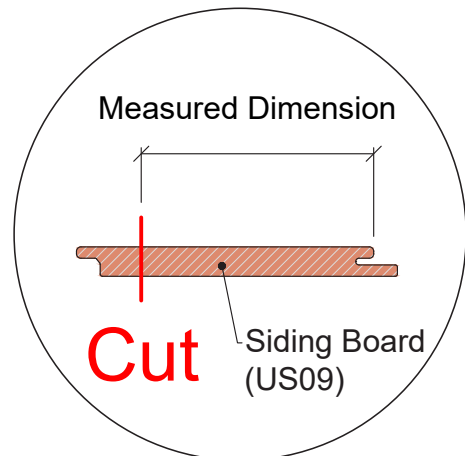


**Detail 97-1**

- 6 Cut the Siding Board (US09) according to the measured length, as shown in **Diagram 98** and **Detail 98-1**.

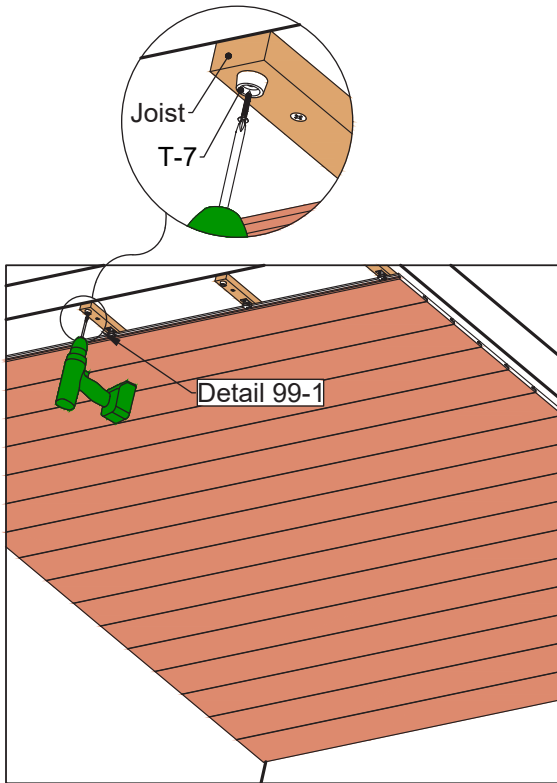


**Diagram 98**

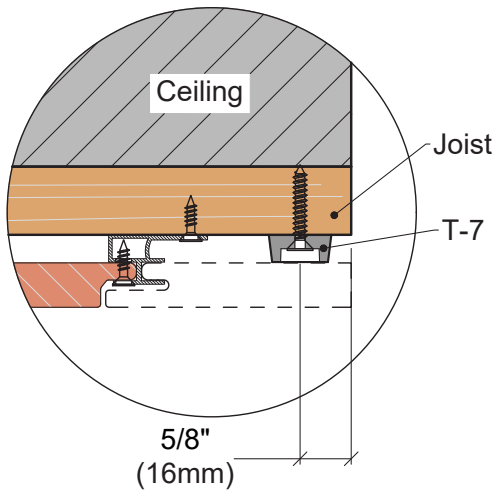


**Detail 98-1**

- 7 Then install the Rubber Stopper (T-7) onto the joist with screws, as shown in **Diagram 99** and **Detail 99-1**.

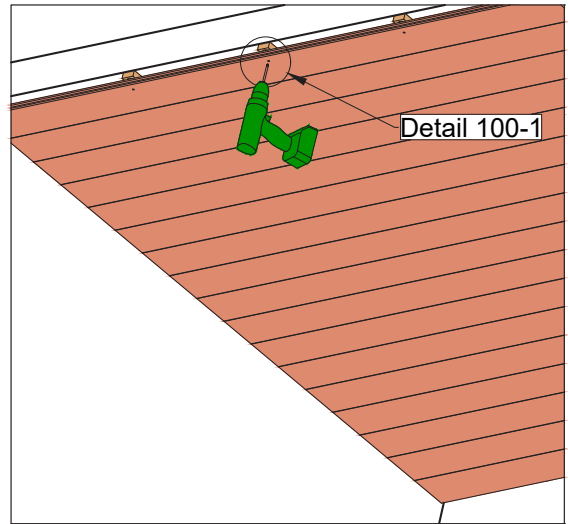


**Diagram 99**

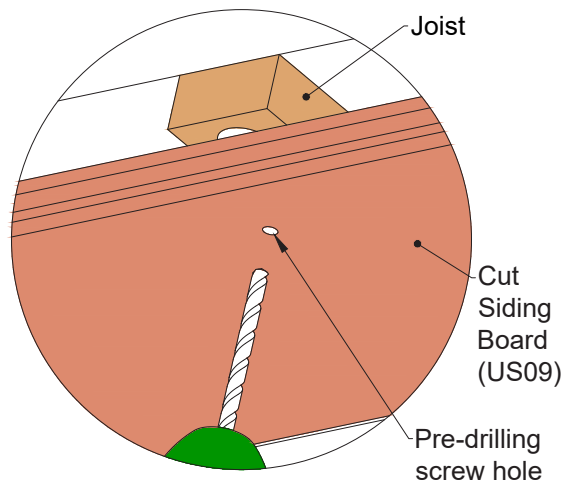


**Detail 99-1**

- 8 Put the cut Siding Board (US09) over the Clip (AW08) in position and pre-drill the screw holes before installation, as shown in **Diagram 100** and **Detail 100-1**.

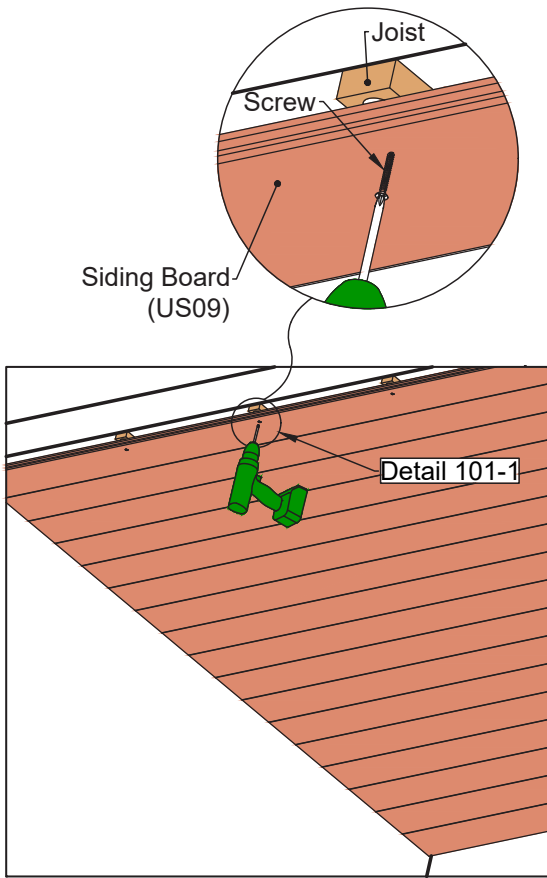


**Diagram 100**

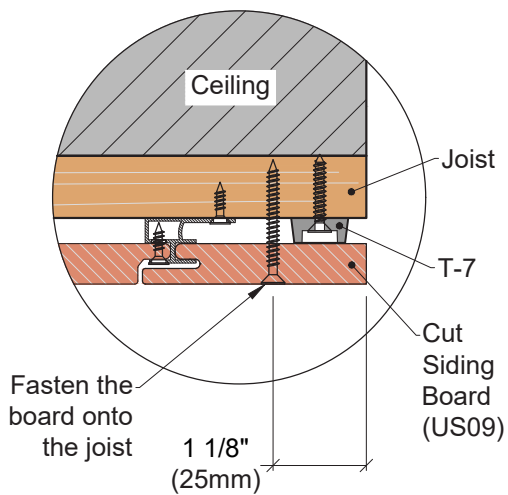


**Detail 100-1**

- 9 Face fix the cut Siding Board (US09) onto each joist along the length of the board over the Rubber Stopper (T-7), as shown in **Diagram 101** and **Detail 101-1**.



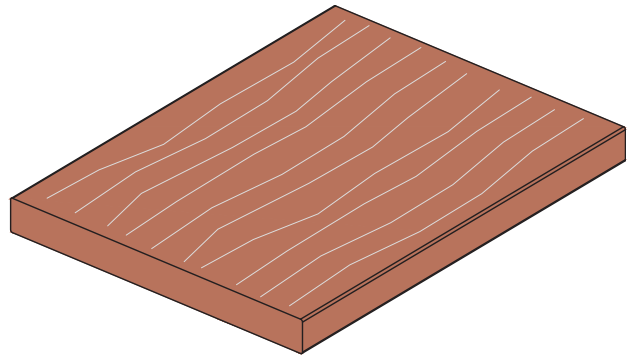
**Diagram 101**



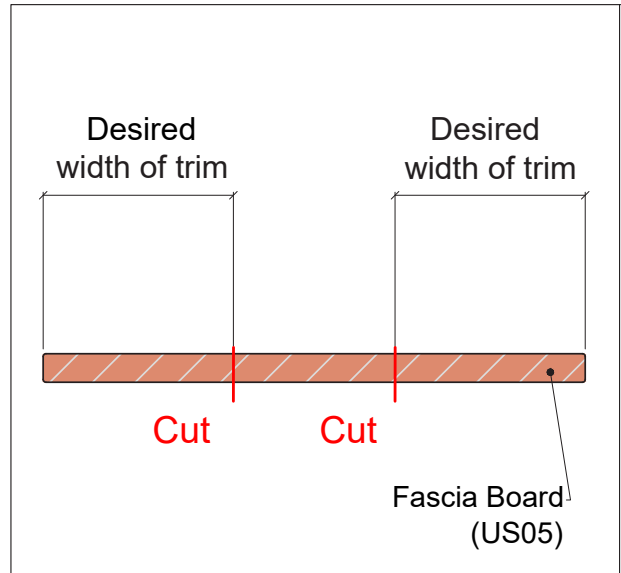
**Detail 101-1**

10 **Trimming**

Cut the Fascia (US05) into the desired width, as shown in **Diagram 102**.

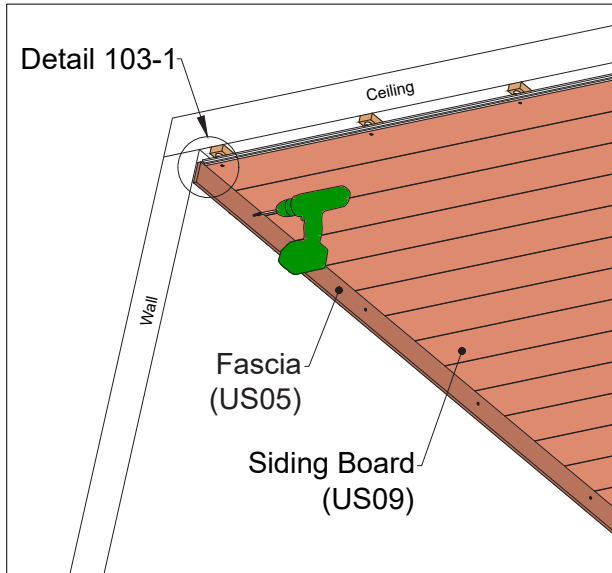


**Fascia (US05)**

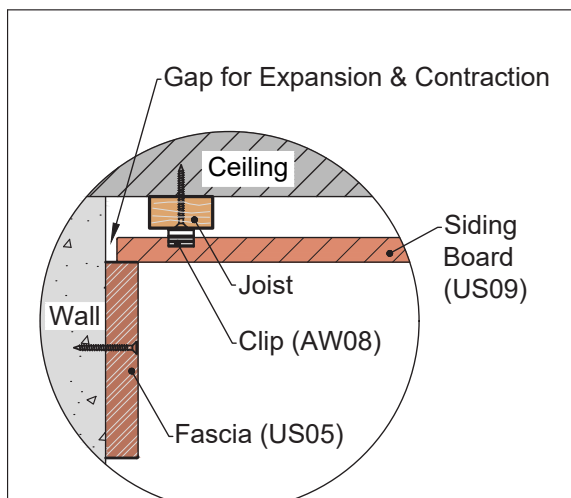


**Diagram 102**

- 11** Put the board's cut edge toward the ceiling board (US09) underside, then face fix it onto the wall with screws at least 19 11/16" (500mm) on center, as shown in **Diagram 103** and **Detail 103-1**.

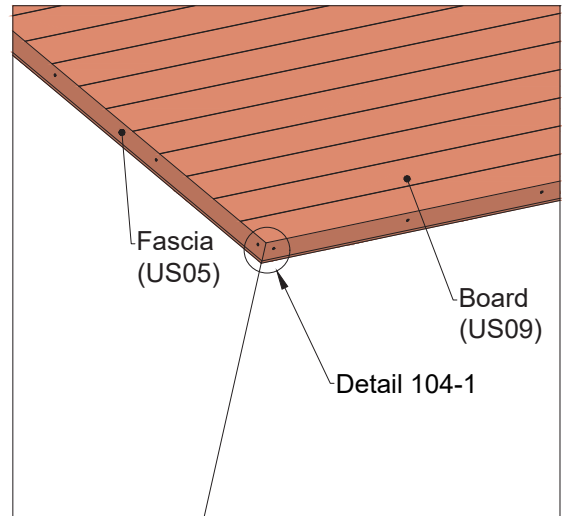


**Diagram 103**

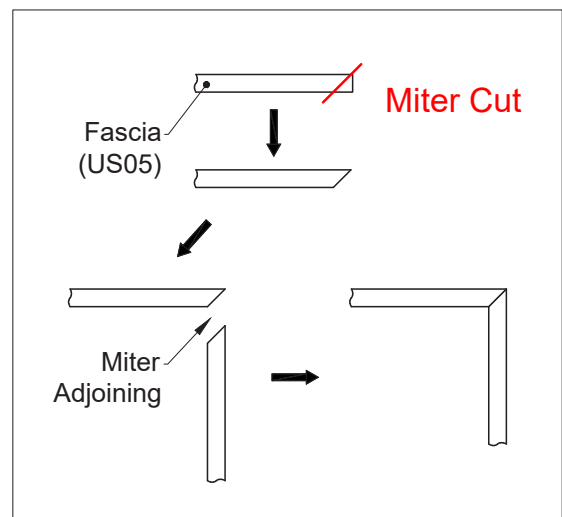


**Detail 103-1**

- 12** Miter cut the trims according to the wall corner's angle for adjoining the trims in the wall corner, as shown in **Diagram 103** and **Detail 103-1**.



**Diagram 104**



**Detail 104-1**



# All Weather Siding Ceiling Installation Guide

v20220215US

©2022 Newtechwood Corporation

NewTechWood® is a registered trademark of Newtechwood Corporation.

To obtain a copy of the most current version of this installation guide,

visit us online at [www.newtechwood.com](http://www.newtechwood.com).

